

Engineered for performance

MEMAPLEX™ SUB-ZERO

Memaplex Sub-Zero has been developed by world-class polymer scientists to deliver maximum performance at sub-zero temperatures as low as -30°C. Created from a unique blend of polymers, Memaplex Sub-Zero is designed to withstand impacts without cracking or fragmenting. It is food-safe, wipe clean and self-coloured for maximum hygiene and ease of care.

Cold Storage barriers incorporate the patented A-SAFE 3-Phase Coupling System, which works in three sequential stages to cushion impact forces and dissipate energy through the barrier and away from fixings. This prevents damage and preserves floors, reducing the costs and downtime associated with repairs and maintenance.

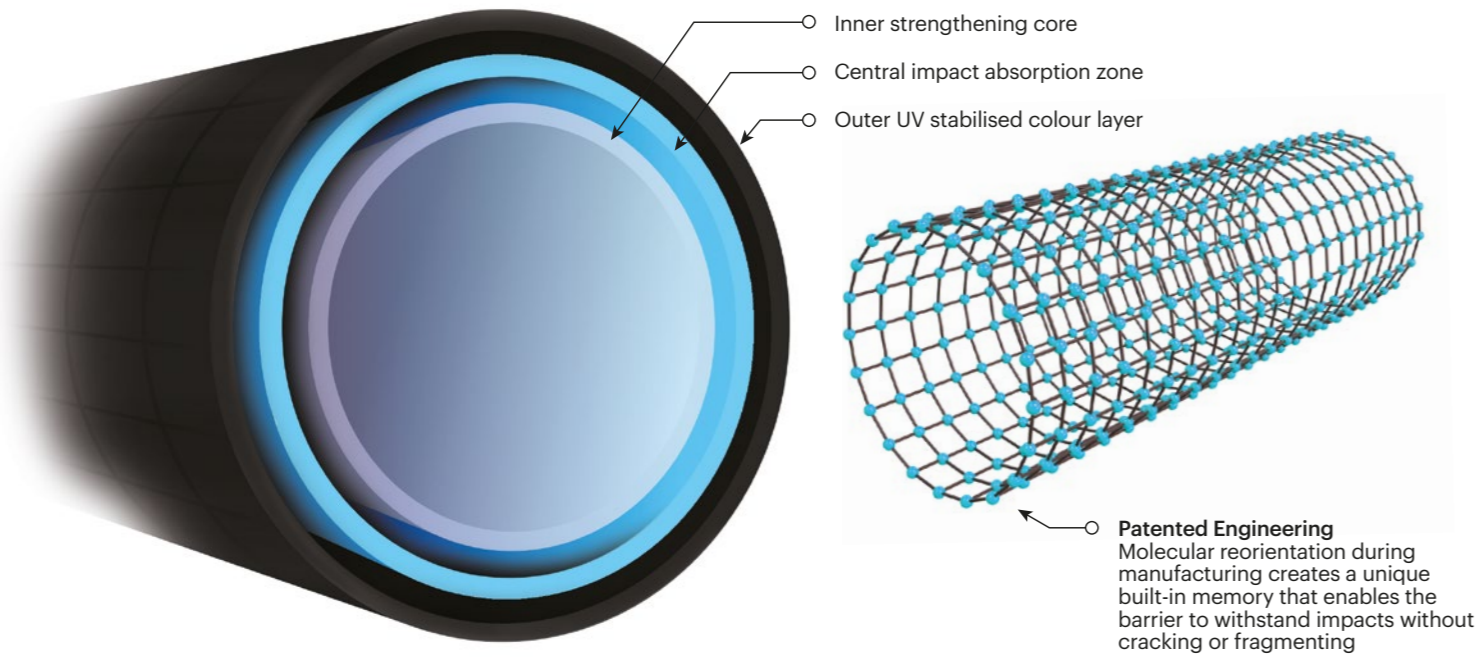

Cold Storage



Technical Information

Material Properties	MEMAPLEX™ SUB-ZERO
Temperature Range	-30°C to 0°C
Ignition Temperature	370°C to 390°C
Flash Point	350°C to 370°C
Toxicity	Not Hazardous
Chemical Resistance	Excellent - ISO/TR 10358
Weathering Stability (Grey Scale)	5/5*
Light Stability (Blue Wool Scale)	7/8**
Static Rating (Surface Resistivity)	10 ¹⁵ - 10 ¹⁶ Ω
Hygiene Seals	Yes

* Weathering scale 1 is very poor and 5 is excellent
 ** Light stability scale 1 is very poor and 8 is excellent



A-SAFE UK
 Ainley House, Ainleys Industrial Estate, Elland, Halifax, HX5 9JP,
 United Kingdom
www.asafe.com



Cold Storage Product Range

The A-SAFE Cold Storage range has been meticulously engineered to provide the highest levels of protection to pedestrians, assets and infrastructure. From the robust rack protection of RackGuard, to PAS 13 compliant fork protection, bollards, barriers and height restrictors, the Cold Storage range offers a full suite of high-performance safety products for applications within very low-temperature environments.

Food-safe, robust and effective to -30°C, Cold Storage products from A-SAFE have been purpose-designed for use in frozen food storage facilities and other challenging sub-zero environments. Benefit from the ultimate in low-temperature performance and reduced maintenance costs without compromising on hygiene.

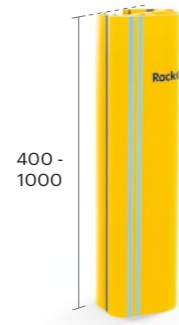

RackGuard™
Cold Storage Rack Leg Protector

1,000 Joules***

- ✓ Compression Hinge
- ✓ Centralising Rubber Lug
- ✓ Simple Installation

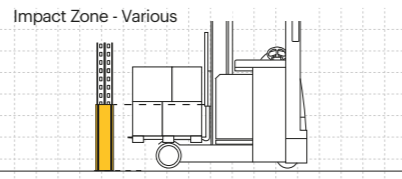

iFlex
Cold Storage Pedestrian Barrier 3 Rail

11,600 Joules*
4.6 Tonne vehicle at 5mph

- ✓ Patented Coupling Technology
- ✓ Electrophoretic Coated Base
- ✓ Hygiene Sealed

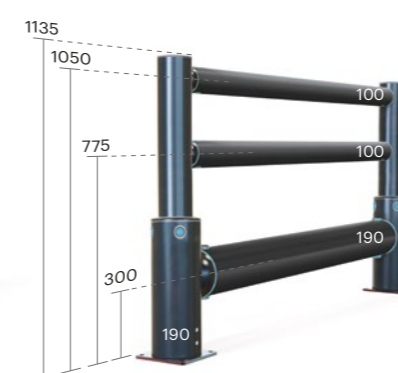
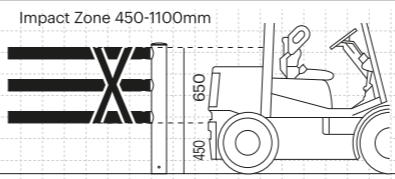

iFlex
Cold Storage Single Traffic Barrier+

30,200 Joules**
8.4 Tonne vehicle at 6mph

- ✓ Patented Coupling Technology
- ✓ Electrophoretic Coated Base
- ✓ Hygiene Sealed

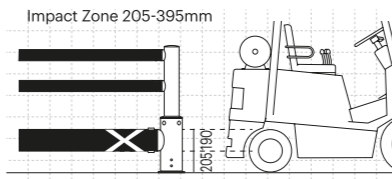

iFlex
Cold Storage Single Traffic Barrier

30,200 Joules**
8.4 Tonne vehicle at 6mph

- ✓ Patented Coupling Technology
- ✓ Electrophoretic Coated Base
- ✓ Hygiene Sealed

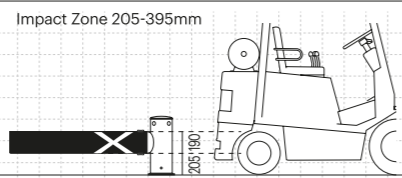

eFlex ForkGuard
Cold Storage Barrier

3,000 Joules***
1.9 Tonne vehicle at 4mph

- ✓ Simple Installation From Above
- ✓ Fork Deflection

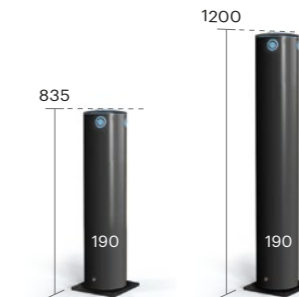
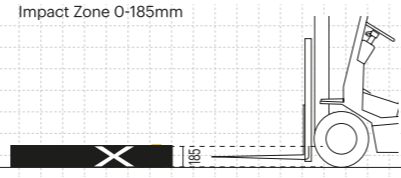

iFlex
Cold Storage Bollard

6,900 Joules***
4.3 Tonne vehicle at 4mph

- ✓ Energy Absorbing Core
- ✓ Electrophoretic Coated Base

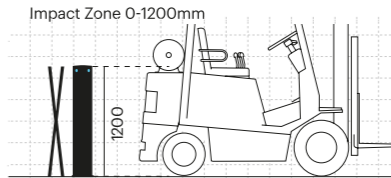

iFlex
Cold Storage Height Restrictor

5,400 Joules***
6 Tonne vehicle at 3mph

- ✓ Energy Absorbing Core
- ✓ Electrophoretic Coated Base
- ✓ In-line coupling for a complete modular solution

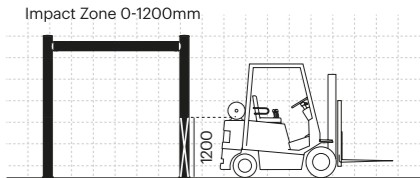

*Ultimate energy load at 45° on a 1.5m rail. **Ultimate energy load at 45° on a 2m rail.
Ultimate energy load at 90°. *Ultimate energy load at 90° on a 1m rail. All measurements in mm.

Joules ratings are provided for your reference only. Our expert technical teams will always recommend the correct specification for your needs. Impact resistance is subject to environmental factors. See individual data sheets for more information. Data is accurate at time of writing.